



The Federation of Motor Sports Clubs of India

National Sports Federation recognized by the Government of India



The Federation of Motor Sports Clubs of India

FMSCI
CROSS CARS
Technical Regulations
2019

Member of



FMSCI Technical



INTRODUCTION

AIMS

The FMSCI is launching the National Cross Car (XC) concept with the aim of reinforcing the ASNs' motor sport pyramid

These cars are intended to provide a platform for youngsters and beginners, safety is a prime target

ENGINE REGULATIONS

The Engine should conform to Article 3.0 of this Technical Regulations

1 GENERAL

1.1 Definition

Cross Car (XC) and Cross Car Junior (XC Jr.):

Cross Cars are rear engine 4-wheeled single-seater vehicles with a multi tubular space frame chassis which must have a safety cage as an integral part of the chassis, as defined in Article 9.

The vehicles must be 2-wheel rear drive.

1.1.1 Dangerous construction

A car, the construction of which is deemed to be dangerous, may be disqualified by the technical delegate for National championship and the Stewards and Scrutineers for other events.

1.2 Modifications and adjunctions allowed or obligatory

All modifications which are not explicitly allowed by the present regulations are forbidden. An authorised modification may not entail a non-authorized modification.

1.2.1 Optional devices

If a device is optional, it must be fitted in a way that complies with regulations.

1.3 Material

Unless explicitly authorised by the present regulations, the use of the following materials is prohibited unless they correspond exactly to the material of the original part:

- Titanium alloy
- Magnesium alloy (< 3 mm thick)
- Ceramics
- Composite or fibre-reinforced material.

Housing, covers, mounting brackets and accessories may be in composite material.

1.3.1 Damaged threads

Damaged threads can be repaired by screwing on a new thread with the same interior diameter ("helicoil" type).

1.4 Fuel – combustive

Free

1.4.1 Oxidant

Only air may be mixed with the fuel as an oxidant.

1.5 Driving aids

Unless explicitly authorised by the present regulations, any driving aid system is prohibited (ABS / ASR / Traction Control / ESP...).

1.6 Energy recovery

Any energy-recovery system other than that provided by the engine is prohibited.

1.7 Telemetry /Voice communications

Any form of wireless data transmission between the car and any person and/or equipment other than the driver is prohibited while the car is on the track.

This definition does not include:

- Voice radio communications between the driver and his/ her team,
- Transponder from the official timekeeping, and
- Automatic timing recording.

None of the previously mentioned transmission data may in any way be connected with any other system of the car (except for an independent cable to the battery only).

On-board data recorders are permitted.

These systems, with or without a memory, may permit only the reading of:

- The engine revs,
- Two indications of temperature,
- The speed of one wheel,
- An X/Y accelerometer according to the following coordinates:

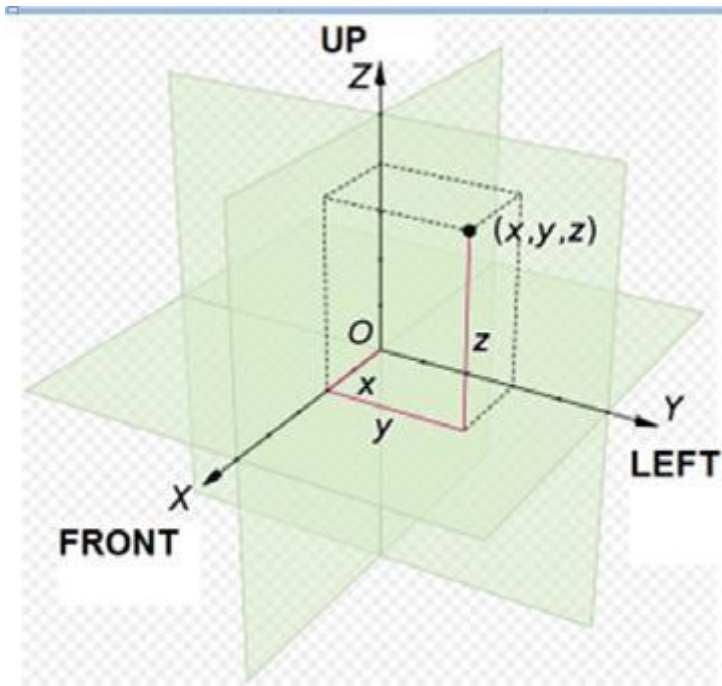

- GPS data,
- Lap times.

The transmission of data by radio and/or telemetry is prohibited.

On-board TV cameras are not included in the above definitions. However, the equipment and supports must first be approved at scrutineering.

Competitors' camera

The camera must not hinder the driver's visibility, exit or extrication in case of emergency.

2 PRESCRIPTIONS FOR CROSS CARS

These cars must comply with the following articles of Appendix J: ARTICLE 251 (Classification and definitions):

- 2.1.9 Mechanical components
- 2.2 Dimensions
 - 2.3.1 Cylinder capacity
 - 2.3.8 Engine compartment
- 2.5.1 Chassis
- 2.5.2 Bodywork
- 2.5.3 Seat
- 2.5.5 Cockpit
- 2.7 Fuel tank

ARTICLE 253 (Safety equipment):

- 3. Lines and pumps
- 14. FIA/SFI approved safety fuel tanks

2.1 Dimensions

2.1.1 Maximum car dimensions

Overall length = 2600 mm

Overall width = 1600 mm (excluding mudguards)

Height = 1400 mm (excluding engine water radiator air intake)

2.1.2 Air intake

For cars with liquid cooling, an air intake 150 mm above the roof over its entire width is allowed, and on either side of the main roll bar in the form of scoops. Only one scoop is allowed per side. Its width may not exceed 150 mm beyond the main roll bar.

2.1.3 Wheelbase

The wheelbase and tracks are free, within the limit of the above.

2.1.4 Ground clearance

No part of the car must touch the ground when all the tyres on one side are deflated. This test must be carried out on a flat surface under race conditions (driver on board).

2.2 Weight

The weight of the vehicle, measured with the driver on board wearing his/her full racing apparel, must be at all times during the competition:

XC - Cross Car: 400 kg minimum

XC Jr - Cross Car Junior: 385 kg minimum

Car minimum weight: 320 kg.

This is not the real weight of the car, with the driver nor his/her full racing apparel. At no time during the competition may a car weigh less than this minimum weight.

2.2.1 Ballast

It is permitted to complete the weight of the car by one or several ballasts provided that they are strong and unitary blocks, fixed by means of tools with the possibility to fix seals, placed on the floor of the cockpit, visible and sealed by the scrutineers.

2.3 Measurements

All measurements must be made while the car is stationary on a flat horizontal surface.

3 ENGINE

NOTE- ALL ENGINES NEED TO BE HOMOLOGATED / TDF BY THE FMSCI. A NEW ENGINE (OE) MUST BE PRESENTED TO THE FMSCI ALONG WITH THE FILLED IN HOMOLOGATION FORM FOR VERIFICATION BY THE FMSCI.

3.1 General

The engine must not undergo any modifications compared to the FMSCI homologated/TDF engine.

3.2 Cylinder capacity

The maximum cylinder capacity is 600 cm³

3.3 Cycle and type

Only 4-stroke (Otto principle) engines with reciprocating pistons and integrated gearbox are authorised.

3.4 Number and layout of cylinders 4 maximum.

Free layout of cylinders.

3.5 Injection

The components of the injection system situated downstream of the air-flow measuring device, and which control the quantity of petrol entering the combustion chamber, may be modified but not replaced, provided that they do not have any influence over the quantity of air admitted. The injectors may be modified or replaced in order to modify their flow rate, but without modifying their operating principle and their mountings.

The injector rail may be replaced with another of free design but fitted with threaded connectors for connecting the lines and the fuel pressure regulator, provided that the mounting of the injectors is identical to the original.

All sensors and actuators, with the exception of the injectors, must remain original, in their original location without a mounting tolerance.

The installation of additional sensors or actuators is prohibited, except for one fuel pressure sensor if the original engine is not equipped with any.

The injection control unit or combined ignition-injection control unit (ECU) is free.

The electrical harness is free while retaining only its original functions.

3.6 Ignition

All sensors and actuators, with the exception of the injectors, must remain original, in their original location.

The installation of additional sensors or actuators is prohibited.

The ignition control unit (ECU) is free.

The electrical harness is free while retaining only its original functions.

3.7 Throttle

There must be a proven means of closing the throttle in the event of failure of the throttle linkage, by means of an external spring operating on each throttle spindle or slide.

3.8 Dynamos, alternators, batteries

Dynamos and alternators may be removed, but each car must have an on-board battery.

The use of any outside source of energy to start the engine of the car on the grid or during a race is forbidden.

3.8.1 Starting on board the car

A starter with an electric or other source of energy on board, operable by the driver when seated in the seat, is mandatory.

3.9 Exhaust system

The exhaust manifold is free after the cylinder head outlet, but it must then include a silencer that enables it to remain within the limits set in Article 2.1.1. or as mentioned in the SUPPLEMENTARY REGULATIONS

A limit of 100 dB/A is imposed for all cars. The noise must be measured in accordance with the FIA noise measuring procedure using a sonometer regulated at "A" and "SLOW", placed at an angle of 45° to and a distance of 500 mm from the exhaust outlet, with the car's engine running at 4500 rpm.

The exhaust pipe must finish at the rear end of the car.

The exit of the exhaust pipe must be situated within the perimeter of the car and less than 10 cm from this perimeter.

Exhaust pipe outlets which point downwards are prohibited.

Adequate protection must be provided in order to prevent heated pipes from causing burns.

3.10 Air filter

The air filter is free, as are the air-filter housing, the filtering components and the connecting pipes.

3.11 Water radiator

The water radiator and its capacity are free. Its location is free, provided that it does not encroach upon the cockpit and is located inside the bodywork.

The air cooling lines upstream of the water radiator as well as the water pipes are free.

3.12 Cooling system

The thermostat is free, as is the control system and the temperature at which the fan cuts in.

The radiator cap and its locking system are free.

The expansion chamber is free, provided that the capacity of the new chambers does not exceed 2.5 litres.

The liquid cooling lines external to the engine block and their accessories are free.

Lines of a different material and/or diameter may be used.

No part of the cooling system may be inside the cockpit.

The fitting of extra cooling fans is permitted.

At any time, the maximum distance between the rear face of the radiator core and the rearmost part of the cooling fan blades is 150 mm.

A duct may be fitted between the radiator core and the cooling fan.

Any system for spraying water onto the engine water radiator is prohibited.

3.13 Engine oil cooling

The oil radiators and their connections are free, provided that they do not give rise to any modifications to the bodywork and are situated within the perimeter of the bodywork.

3.14 Oil tanks, engine water expansion chambers, oil and water radiators They must be isolated from the cockpit by means of bulkheads so that in the case of spillage, leakage or failure of a tank / radiator, no liquid may enter into the cockpit.

4 FUEL CIRCUIT

4.1 Fuel pumps

Fuel pumps (including their number) are free provided that they are installed either: Inside the fuel tank, or Outside the fuel tank, protected by a leak-proof and flameproof cover and must be outside the cockpit.

Petrol filters with a maximum unit capacity of 0.5 l may be added to the fuel feed circuit.

4.2 Petrol lines

Flexibles lines must be of aviation quality. The installation is free, provided that the prescriptions of Article 253-3 of Appendix J are respected. The automatic fuel cut-off system described in Article 253-3.3 is compulsory.

4.3 Fuel tank

The fuel tank must be homologated to one of the following FIA/SFI standards: FT3-1999, FT3.5-1999, FT5-1999

SFI standards 28.1,28.2,28.3

. It must be in accordance with the specifications of FMSCI Article 253-14.

The capacity of the fuel tank is free

The location of the fuel tank must respect the following conditions:

Must not be located in the cockpit, must be situated behind the seat in side view and must be separated from the cockpit by a firewall.

Must be mounted in a sufficiently protected location inside the base construction structure and be firmly attached to the car.

The fuel tank must be isolated from the engine and the exhaust by a leak-proof, non-inflammable bulkhead.

The fuel circuit must comprise only the following parts:

- One fuel supply outlet for the engine,
- One fuel return into the tank,
- One breather in conformity with Article 253-3.4 of Appendix J.

The storing of fuel on board the car at a temperature of more than 10° centigrade below the ambient temperature is forbidden.

4.3.1 Ageing of tanks

The ageing of safety tanks entails a considerable reduction in the strength characteristics after approximately five years.

No bladder may be used more than 5 years after the date of manufacture, unless inspected and recertified by the manufacturer for a period of up to another two years.

A leak-proof cover, minimum 5 mm thick, made from non-flammable material, easily accessible and removable only with the use of tools, must be installed in the protection for FT3-1999, FT3.5-1999 or FT5-1999 and SFI tanks, in order to allow the checking of the validity expiry date.

4.4 Filling and venting

The location of the filler holes is free, but they must not protrude beyond the perimeter of the chassis.

5 ELECTRICAL EQUIPMENT

5.1 Battery(ies)

Make and type of battery(ies):

The make, capacity and cables of the battery(ies) are free.

Each battery must be a dry battery.

Location of the battery(ies):

Its (their) location is free.

Battery fixing:

Each battery must be securely fixed and the positive terminal must be protected.

It must be attached to the body using a metal support and two metal clamps with an insulating covering, fixed to the floor by bolts and nuts.

For attaching these clamps, metallic bolts with a diameter of at least 6 mm must be used, and under each bolt, a counter plate at least 3 mm thick and with a surface of at least 20 cm² beneath the floor.

5.2 Alternator / Generator / Starter

Free.

5.3 General circuit breaker

The general circuit breaker must cut all electrical circuits, battery, alternator or dynamo, fuel pumps, lights, hooters, ignition, electrical controls, etc.) and must also stop the engine.

It must be a spark-proof model, and must be accessible from inside and outside the car.

As for the outside, the triggering system of the circuit breaker must compulsorily be situated at the base of the front roll bar. It must be marked by a red spark in a white-edged blue triangle with a base of at least 12 cm.

5.4 Lights

Brake light:

Each car must be fitted with a minimum of two red LED rear lights of Ø 80 mm (36 LEDs minimum) or with two rain lights approved by the FIA (FIA Technical List No. 19) working whenever the brakes are on.

They must be positioned between 1400 mm and 800 mm above ground level and must be visible from the rear.

They must be placed symmetrically in relation to the longitudinal axis of the car and in the same transverse plane.

Rear light:

Each car must be fitted with one red LED rear light of Ø 80 mm (36 LEDs minimum) or with two rain lights approved by the FIA (FIA Technical List No. 19). They must be clearly visible from the rear, and it must be permanently switched on when the car is driving and must be positioned between 1400 mm and 800 mm above ground level.

It must be possible for the driver sitting at his steering wheel to switch them on.

6 TRANSMISSION

6.1 Type of gearbox

The engine integrated gearbox must not undergo any modifications compared to the homologated one, unless such modifications are explicitly allowed by the present regulations.

Gear changes will be carried out only by means of a lever.

The principle of changing gears by using paddles on the steering wheel or steering column is prohibited.

6.2 Transmission system

Free, but the two rear wheels must be attached to the same shaft, which may have universal joints.

A secondary chain drive is permitted.

A reverse gear is compulsory.

The reverse gear efficiency check will be carried out with the front wheels at full lock on a gravel type surface.

Rear axle drive unit:

If the car is equipped with a rear axle type drive unit, the competitor must have a technical form describing the operating principle and the number of teeth of the different gears.

Traction control is prohibited.

A launch control switch is prohibited.

6.3 Clutch

Free, but must be operated by the driver's foot.

6.3.1 Clutch fluid tank

If inside the cockpit, it must be securely fastened and be protected by a leak-proof and flameproof cover or must be made out of metallic material.

6.4 Sensors

Any sensor, contact switch or electric wire on the four wheels and gearbox is forbidden. A gear cut sensor is allowed.

Exception:

Only one sensor for displaying the ratio engaged is authorised on the gearbox, on condition that the sensor+electric wire+display assembly is completely independent of the engine control system.

Furthermore, this wire may not be included in the car's main wiring loom; it must be independent and separate. It is also preferable for it to be of a different colour, as this makes it easier to identify.

7 SUSPENSION

7.1 Suspension system

Cars must be fitted with a sprung suspension. The operating method and the design of the suspension system are free.

The use of active suspension is forbidden.

Coil springs are compulsory. The number is free. They must be made from steel alloy.

Suspension parts made partially or entirely from composite materials are prohibited.

7.2 Shock absorbers

Only one shock absorber per wheel is authorised. Only maximum **2-way** adjustment systems are permitted. All shock absorbers must be independent of each other. Inertia shock absorber systems are prohibited. The checking of the operating principle of the shock absorbers must be carried out as follows:

– Once the springs are removed, the car must sink down to the bump stops in less than 5 minutes.

With regard to their principle of operation, gas-filled shock absorbers are considered as hydraulic shock absorbers.

If the shock absorbers have separate fluid reserves located in the cockpit, these (including hoses and joints) must be securely fastened and be protected by a liquid-proof and flameproof cover.

A suspension travel limiter may be added.

Only one cable per wheel is allowed, and its sole function must be to limit the travel of the wheel when the shock absorber is not compressed.

Water cooling or heating systems are prohibited.

Whatever the type of the shock absorbers, the use of ball or roller bearings with linear guidance is prohibited. Changes to the spring and shock absorber settings from the cockpit are prohibited.

7.3 Antiroll bars

They must respect the following:

- Their operating principle must be solely mechanical.
- The antiroll bars and their links must be made from metallic material and must not be adjustable from the cockpit.
- Under no circumstances may the antiroll bars be connected to one another.

8 RUNNING GEAR

8.1 Wheels

The rims must have a maximum diameter of 10” and a maximum width of 6” at the front and 8” at the rear. Rims must be made from either iron-based alloy or aluminum alloy.

8.2 Wheel attachment

Central wheel nut fixation systems are prohibited.

8.3 Tyres

The complete wheel (flange + rim + inflated tyre) must always fit inside a U-shaped gauge of which the extremities are 260 mm apart, the measurement to be made on an unloaded part of the tyre.

Any modification – retreading, mechanical or chemical treatment – is prohibited.

Any means of warming the tyres – tyre blankets, ovens, roller systems, etc. – is prohibited.

8.3.1 Pressure control valves

Pressure control valves on the wheels are forbidden.

8.4 Brakes

Free, but must comply with Article 253-4 of Appendix J.

Brake lines must comply with Article 253-3 of Appendix J.

A hydraulic handbrake system is authorised; it must be efficient and simultaneously control the two front wheels or the two rear wheels.

A central braking system on the rear axle is permitted.

Brake discs must be made from iron-based alloy.

Carbon brake discs are forbidden.

8.4.1 Brake fluid tanks

If inside the cockpit, they must be securely fastened and be protected by a leak-proof and flameproof cover or must be made out of metallic material.

8.5 Steering

The steering system and its position are free, but only a direct mechanical linkage between the steering wheel and the steered wheels is permitted.

Flexible steering controls by e.g. chain, cable, etc. are prohibited.

Four-wheel steering is forbidden.

Any power steering system is forbidden.

8.6 Steering column

Free, but it must be fitted with a retractable device in case of impact.

The retractable part must derive from a series vehicle and must have a minimum travel of 50 mm.

The steering wheel must be fitted with a quick release mechanism in compliance with Article 255-5.7.3.9 of Appendix J.

Controls and buttons on the steering wheel are prohibited.

9 CHASSIS

The multi-tubular space frame structure formed by the compulsory base construction of the safety cage, compulsory reinforcement tubes and any other tubular structure or elements welded together for the functioning of the car, should be considered as “the chassis”.

9.1 General

The fitting of a safety cage is compulsory. Unless otherwise stated in the applicable technical regulations, it may be either:

- a) Fabricated in compliance with the requirements of the following articles;
- b) Homologated or certified by an ASN in compliance with the requirements of the following articles. Homologated or certified chassis will be published on FMSCI Technical List No. (TBD).

An authentic copy of Any cage which is homologated by an ASN must be identified by means of an identification plate affixed to it by the manufacturer; this identification plate must be neither copied nor moved (e.g. embedded, engraved, metallic plate).

The identification plate must bear the name of the manufacturer, the homologation or certification number of the ASN homologation form or certificate and the individual series number of the manufacturer.

The homologation document or certificate bearing the same numbers, approved by the ASN and signed by qualified technicians representing the manufacturer, must be presented to the competition’s scrutineers.

Any modification to a homologated or certified safety cage is forbidden.

To be considered as a modification: any operation carried out on the cage by machining or welding that involves a permanent modification of the material or the safety cage.

All repairs to a homologated or certified safety cage, damaged after an accident, must be carried out by the manufacturer of the cage or with his approval.

9.2 Definitions

9.2.1 Safety cage

Multi-tubular structure installed and welded to the chassis or been an integral part of it, the function of which is to reduce the deformation of the cockpit in case of an impact.

9.2.2 Roll bar

Tubular frame forming a hoop with two mounting feet.

9.2.3 Main roll bar (Drawing 279B-3)

Transverse and near-vertical (maximum angle +/-10° to the vertical) single piece tubular hoop located across the car just behind the driver’s seat.

The tube axis must be within one single plane.

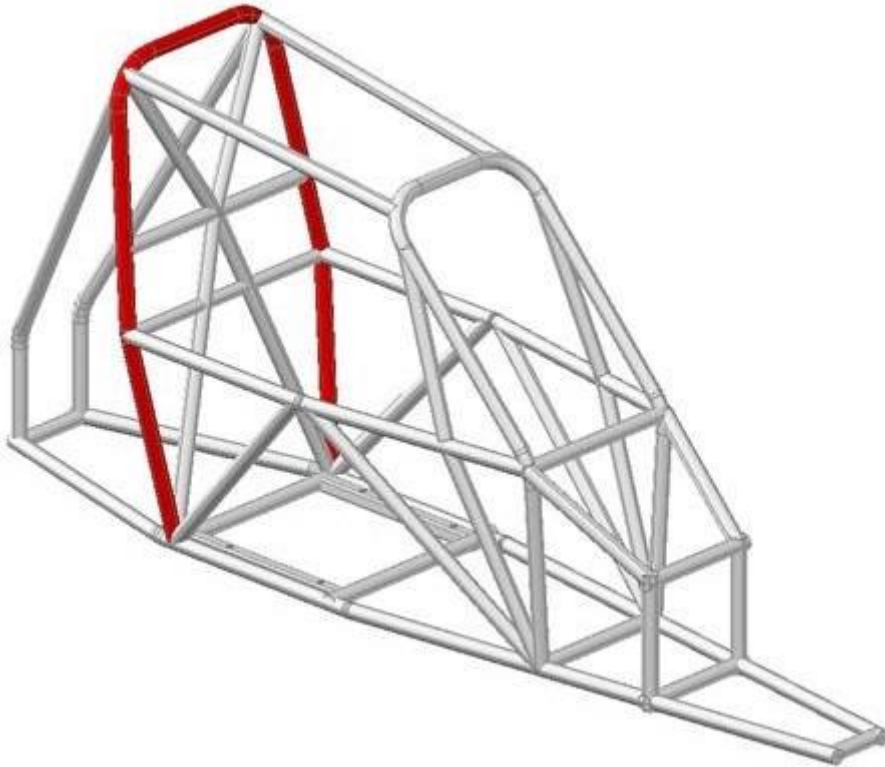

9.2.4 Front roll bar (Drawing279B-4)

Similar to main roll bar but located in front of the driver's seat at windscreen level.

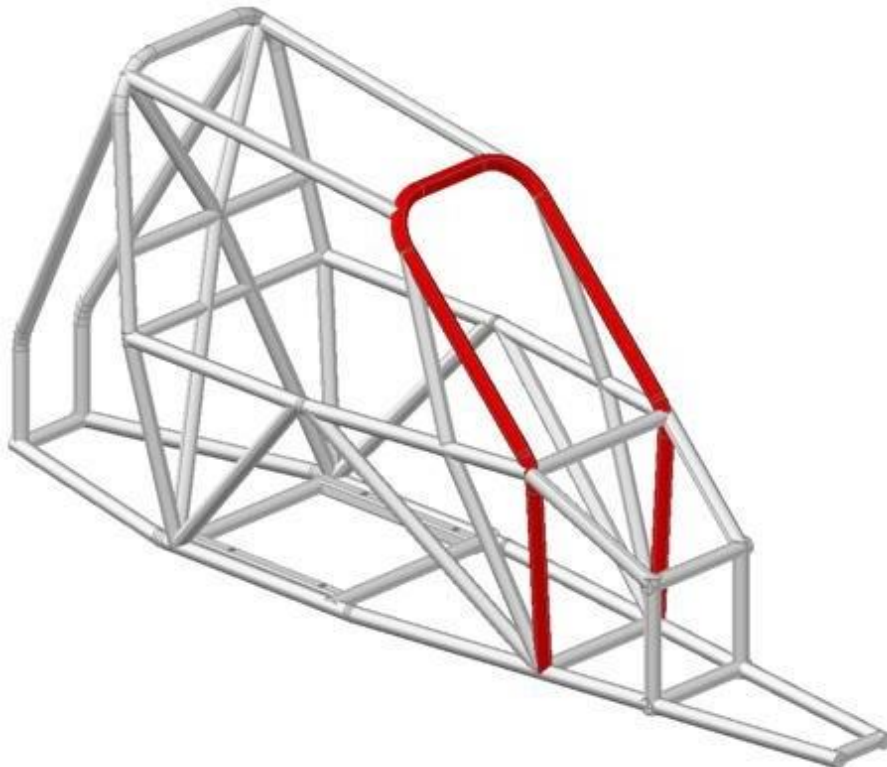

9.2.6 Lateral half-roll bar (Drawing 279B-5)

Lateral roll bar without the rear pillar.

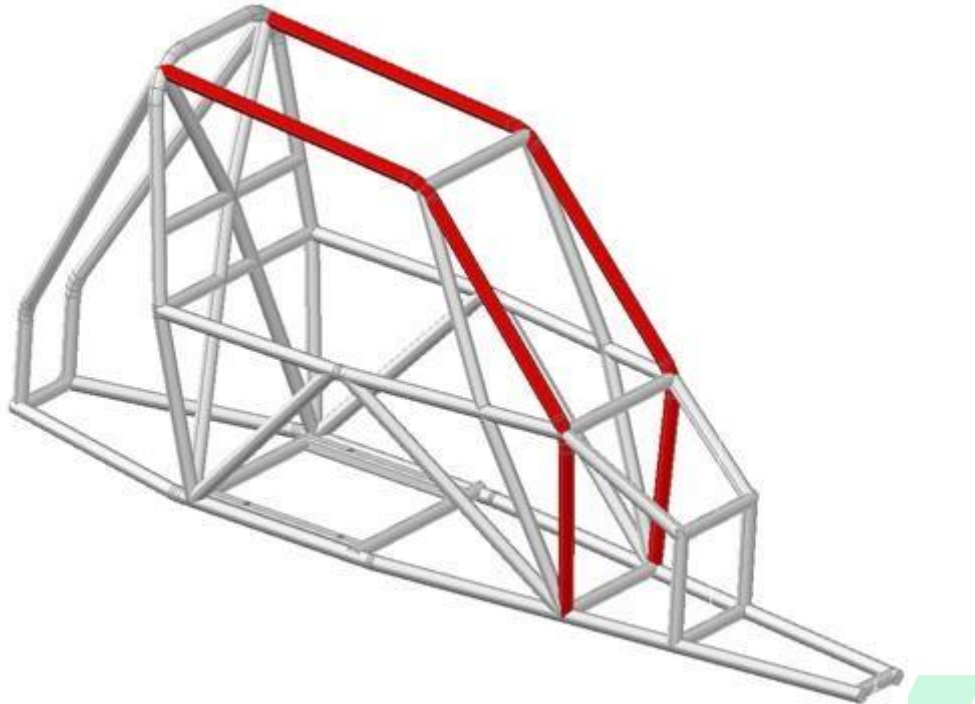

9.2.7 Longitudinal member (Drawing 279B-6)

- a) Near-longitudinal single piece tube joining the upper parts of the front and main roll bars.
- b) Near-longitudinal single piece tube joining the mounting feet of the front roll bar, main roll bar, and rear backstays.

The Federation of Motor Sports Clubs of India

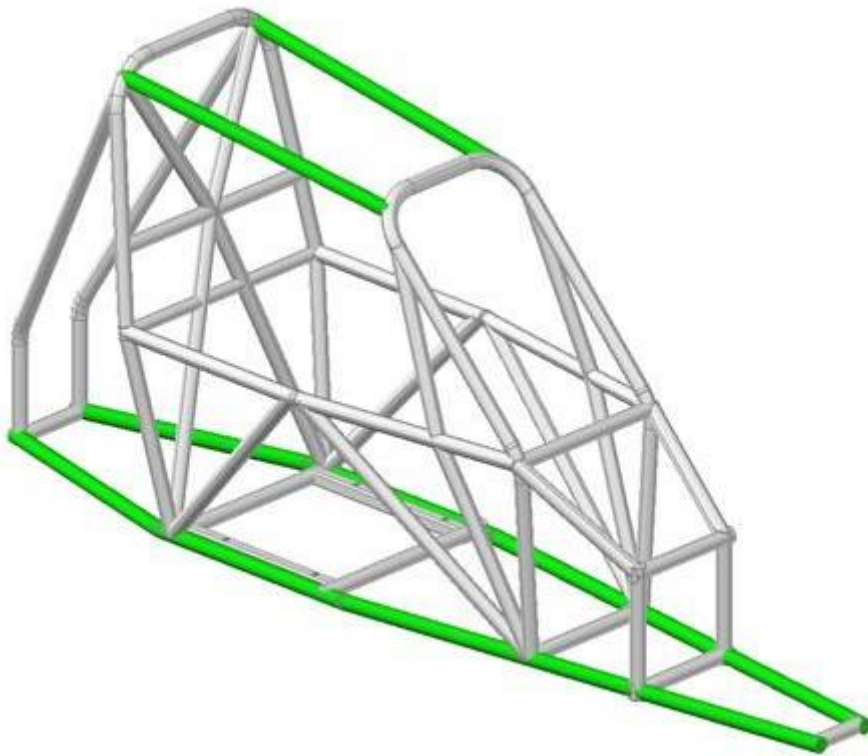

9.2.8 Transverse member (Drawing 279B-7)

- a) Near-transverse single piece tube joining the upper parts of the lateral half-roll bars.
- b) Near-transverse single piece tube joining the 2 mounting feet of the front roll bar, of the main roll bar, of the backstays, or the 2 front and rear ends of the lower longitudinal members.

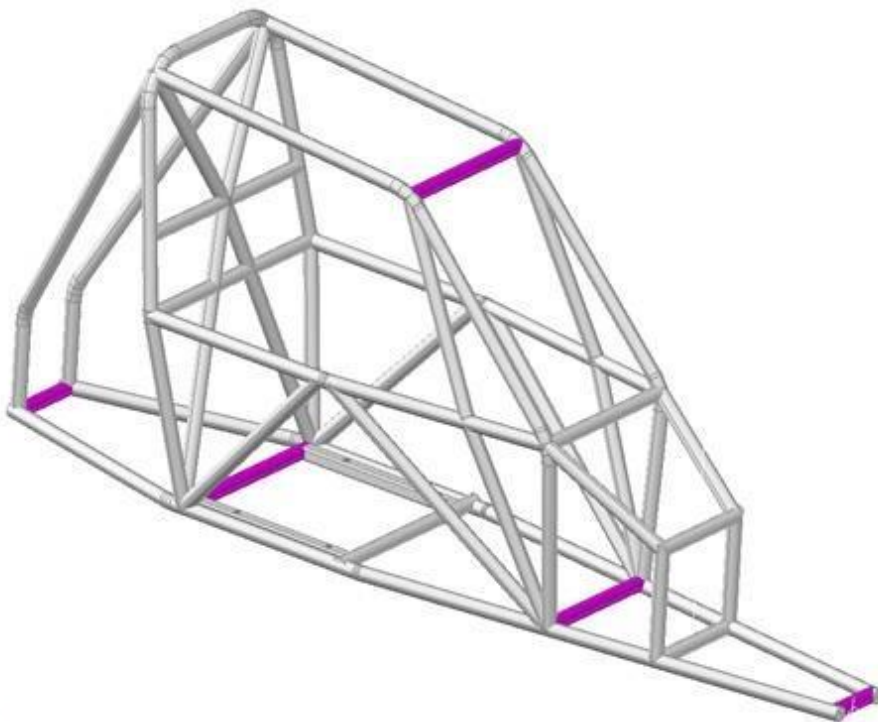

9.2.9 Diagonal member (Drawing 279B-8)

Transverse tube between:

One of the top corners of the main roll bar, and the lower mounting point on the opposite side of the roll bar.

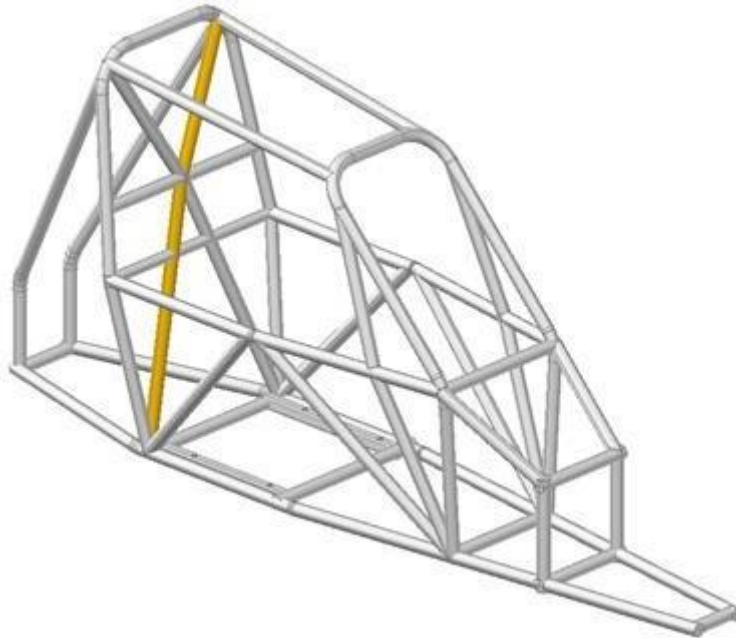

9.2.10 Removable members

Members of a safety cage which must be able to be removed.

9.2.11 Cage reinforcement

Member added to the safety cage to improve its strength.

9.2.12 Mounting foot

End of a roll bar tube to permit its welding to the chassis.

9.2.13 Gusset (Drawing 253-34)

Reinforcement for a bend or junction made from bent sheet metal with a U shape the thickness of which must not be less than 1.0 mm.

The ends of this gusset (point E) must be situated at a distance from the top of the angle (point S) of between 2 and 4 times the outer diameter of the biggest of the tubes joined.

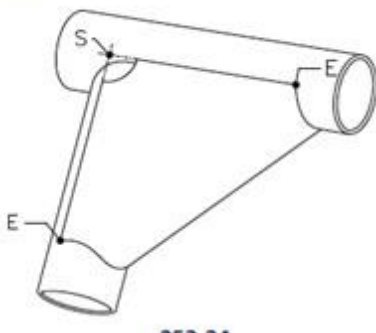

A cut-out is permitted at the top of the angle but its radius (R) must be no greater than 1.5 times the outer diameter of the biggest of the tubes joined.

The flat sides of the gusset may have a hole the diameter of which must not be greater than the outer diameter of the biggest of the tubes joined.

9.3 Assembly of the safety cage

The safety cage must be welded onto the structure to which the suspension loads are transmitted (with, if necessary, additional reinforcement at the joint between the chassis and the foot of the roll bar).

The mounting points of the front, lateral half and main roll bars must be situated at least at the level of the cockpit floor.

The chromium plating of all or part of the cage is forbidden.

Tubes must not carry fluids or any other item.

The safety cage must not unduly impede the entry or exit of the driver.

9.4 Specifications

9.4.1 Base construction

The base construction must be made according to one of the following designs:

9.4.1.1 Base construction 1 (Drawing 279B-1)

- 1 main roll bar.
- 1 front roll bar.
- 2 longitudinal members joining the upper part of the main and front roll bars.
- 2 backstays with 2 near-vertical extensions of the same section and quality going down to the floor level and to the rear end of the car.
- 2 longitudinal side members joining the vertical extensions to the backstays, main roll bar and front roll bar, ending in front of the pedal box.
- 4 transverse members connecting the vertical extensions to the backstays, main roll bar, front roll bar and the front ends of the two lower longitudinal side members.
- 2 transverse members connecting each side of the main roll bar, 1 at the height of the door bars (see Article 9.4.2.1.2) and a second one for the safety harnesses (see Article 11.2).

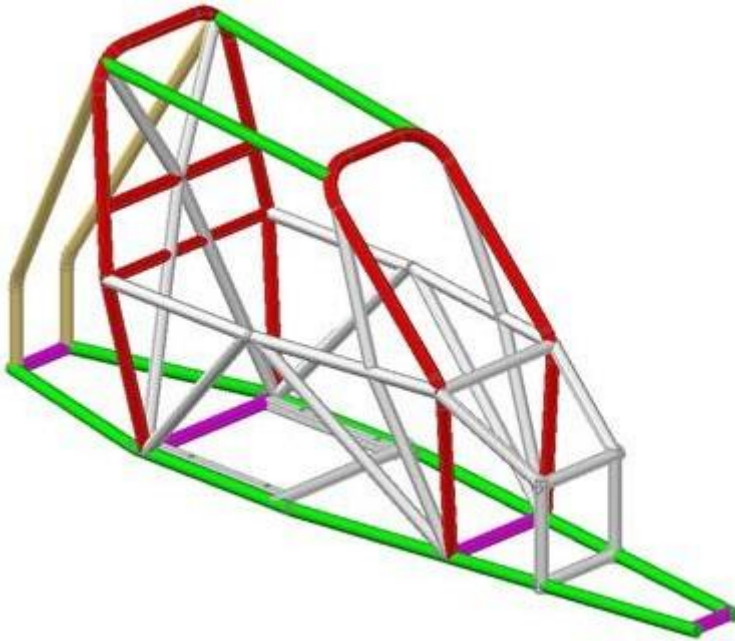

9.4.1.2 Base construction2 (Drawing 279B-2)

- 1 main roll bar.
- 2 lateral half-roll bars.
- 1 transverse member joining the upper part of the lateral half-roll bars.
- 2 backstays with 2 near vertical extensions of the same section and quality going down to the floor level and to the rear end of the car.
- 2 longitudinal side members joining the vertical extensions to the backstays, main roll bar and lateral half-roll bar, ending in front of the pedal box.
- 4 transverse members connecting the vertical extensions to the backstays, main roll bar, front roll bar and the front ends of the two lower longitudinal side members.
- 2 transverse members connecting each side of the main roll bar, 1 at the height of the door bars (see Article 9.4.2.1.2) and a second one for the safety harnesses (see Article 11.2).

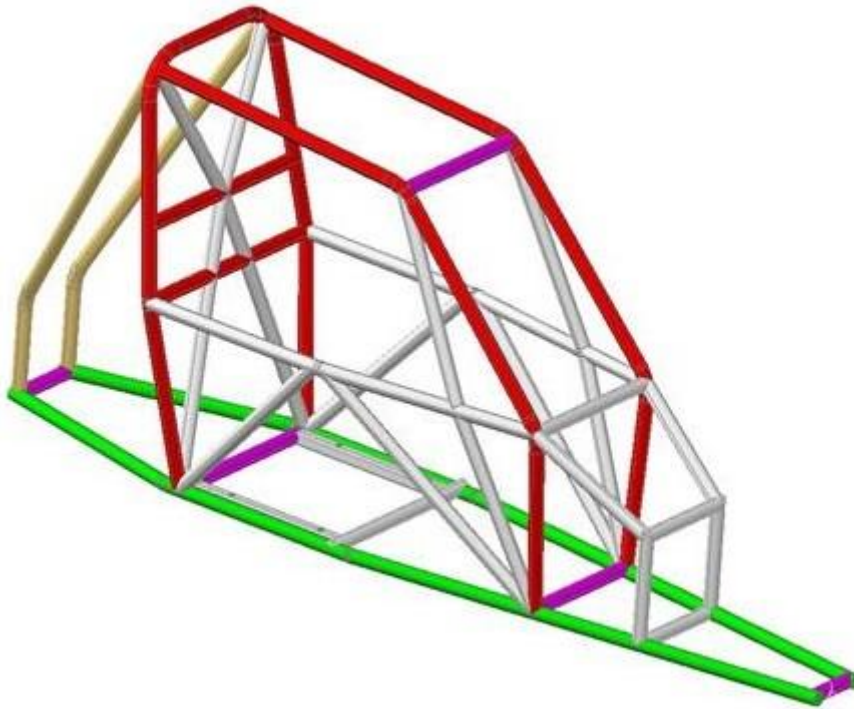

9.4.1.3 The vertical part of the main roll bar must have only one bend between its lower part and its upper part.

The pillar of a front roll bar (or the front pillar or half-roll bar) must have only one bend between its lower part and its upper part.

The angle between the lower part of the front roll bar and the longitudinal side member must be $90^\circ \pm 1^\circ$.

The following connections must be situated at the roof level:

- Longitudinal members to the front and main roll bars,
- Lateral half-roll bar to the main roll bar,
- The backstays must be attached at the roof level and near the top outer bends of the main roll bar, on both sides of the car.

9.4.1.4 Removable members

All the base construction members of the safety cage mounted behind the main roll bar may be made with removable members.

The attachment points to the main roll bar must be 4 (four) points minimum and 6 (six) points maximum.

The dismantable joints used must comply with a type approved by the FIA (Drawings 253-38 or 253-39).

They must not be welded once assembled.

The screws and bolts must have a minimum quality of 10.9 (ISO standard) and a minimum size of M10.

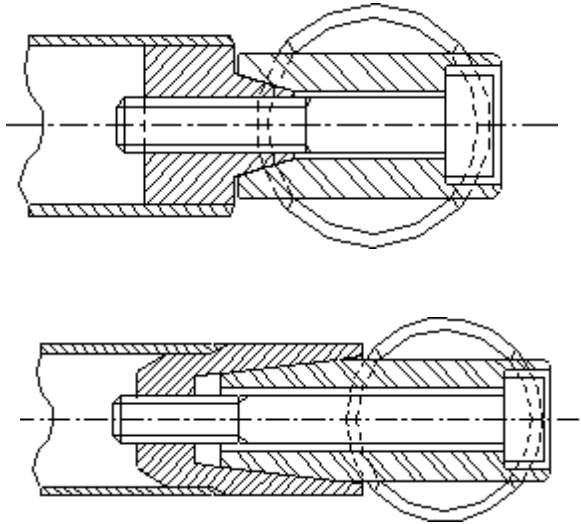

9.4.2 Design

Design is free, as long as it includes all the mandatory members defined in Articles 9.4.1.1 and 9.4.1.2.

Once the base construction is defined, it must be completed with compulsory members and reinforcements (see Article 9.4.2.1), to which optional members and reinforcements may be added.

Unless explicitly permitted, all members and tubular reinforcements must be single pieces.

9.4.2.1 Other compulsory members

9.4.2.1.1 Diagonal member (Drawing 279B-9)

The cage must have two diagonal members on the main roll bar according to Drawing 279B-9.

Members must be straight.

The Federation of Motor Sports Clubs of India

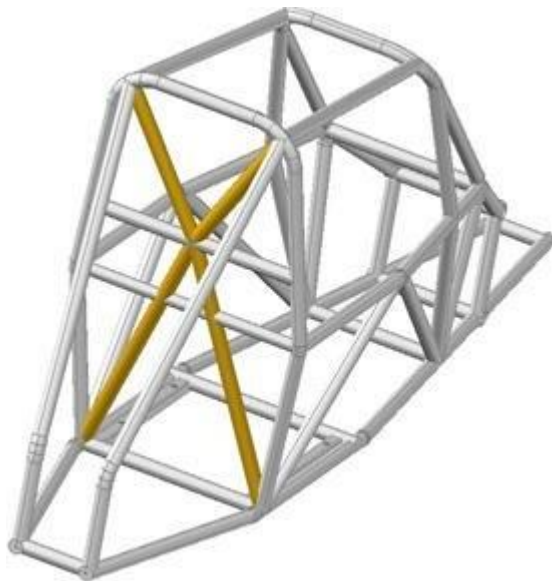

9.4.2.1.2 Door bars (Drawing 279B-10)

Longitudinal members must be fitted on each side of the car according to Drawing 279B-10.

The design must be identical on both sides.

The side protection must be as high as possible, but its upper attachment point must not be higher than half the height of the lateral cockpit opening measured from its base.

The lower attachment points of the members must be fitted directly onto the longitudinal side members, less than 100 mm from the junctions between the mounting points of the main and front roll bars and the longitudinal side members.

The connection of the door bars to the windscreen pillar reinforcement (Drawing 279B-11) is compulsory.

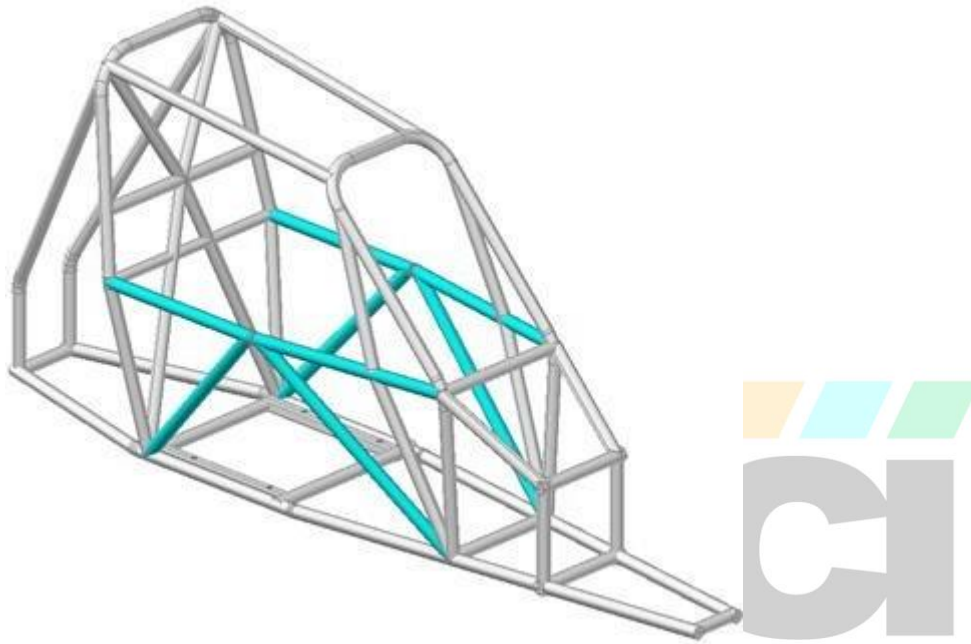

9.4.2.1.3 Windscreen pillar reinforcement (Drawing 279B-11)

It must be fitted on each side of the front roll bar (Drawing 279B-11).

It may be bent on condition that it is straight in side view and that the angle of the bend does not exceed 20°.

Its upper end must be at the junction between the front (lateral) roll bar and the longitudinal (transverse) member.

Its lower end must be at the (front) mounting foot of front (lateral) roll bar.

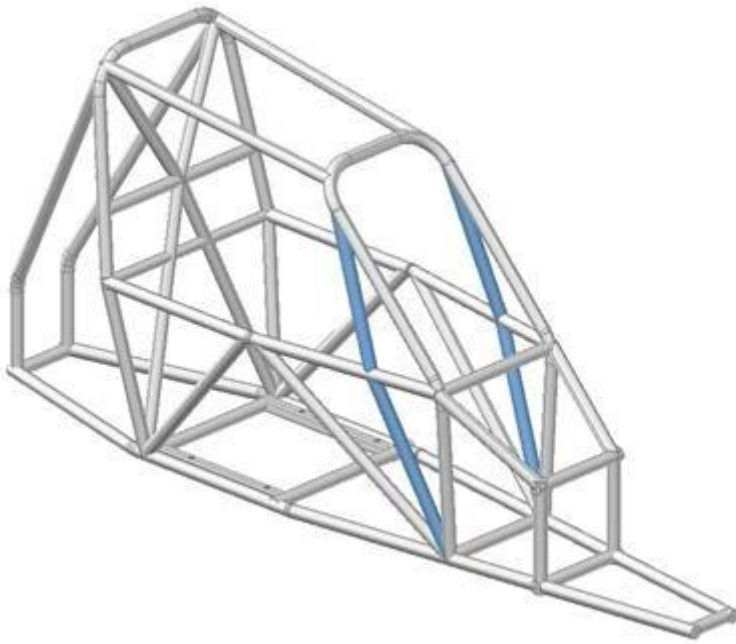

9.4.2.1.4 Transverse member on the front roll bar (Drawing 279B-12)

The transverse member fixed to the front roll bar must not encroach upon the space reserved for the driver.

It may be placed as high as possible but its lower edge must not be positioned below the steering column.

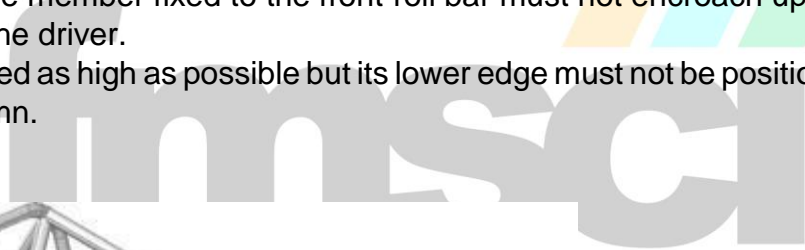

s Clubs of India

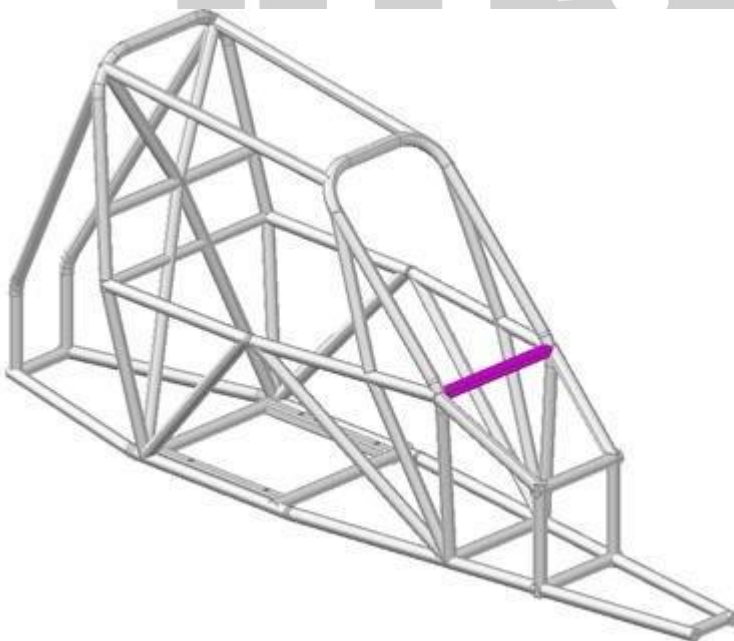

9.4.2.1.5 Pedal box-frame (Drawing 279B-13)

Tubular frame forming a cashbox in front of the pedal box.

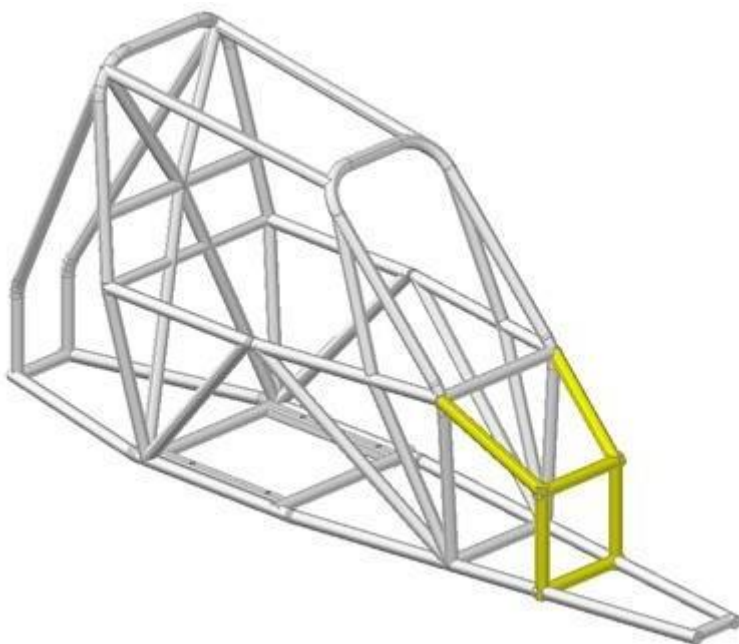

9.4.3 Tube specifications

Only tubes with a circular section are authorised. Specifications of the tubes used:

TABLE

Material	Min.tensile strength	Minimum dimensions (mm)	Use
Cold drawn seamless unalloyed carbon steel (see below) containing a maximum of 0.3 % of carbon	350 N/mm ²	40 x 2 mm	<ul style="list-style-type: none"> – Main roll bar – Front roll bar or – Lateral half-roll bar – 2 transverse members fitted to the main roll bar
		40 x 1.5mm	Other parts of the safety cage (unless otherwise indicated in the articles above)

NOTE:

For unalloyed steel, the maximum content of additives is 1.7% for manganese and 0.6% for other elements.

In selecting the steel, attention must be paid to obtaining good elongation properties and adequate weldability.

The tubing must be bent by a cold working process and the centreline bend radius must be at least 3 times the tube diameter.

If the tubing is ovalised during bending, the ratio of minor to major diameter must be 0.9 or greater.

The surface at the level of the bends must be smooth and even, without ripples or cracks.

9.4.4 Guidance on welding

Welding must be carried out along the whole perimeter of the tube.

All welds must be with full penetration and preferably using a gas-shielded arc.

When using heat-treated steel the special instructions of the manufacturers must be followed (special electrodes, gas protected welding).

9.4.5 Protective padding

Where the driver's body could come into contact with the safety cage, flame-retardant padding must be provided for protection.

Each pad must be fixed in such a way that it is not moveable from the tube.

9.5 Cockpit

9.5.1 Dimensions

The width of the cockpit, maintained over 500 mm from the rearmost point of the seat in a horizontal plane towards the front, must not be less than 600 mm measured at the mid-point of the vertical height of the cockpit.

The location provided for the seat must have a minimum width of 450 mm maintained over the complete depth of the seat.

The minimum vertical height of the safety cage is **1050** mm between the cockpit floor (at seat location) measured at a point 300 mm forward of the main roll bar bottom and a line joining (on the outside) the two main roll bars (front and main).

The two safety roll bars must be high enough for a line extended from the top of the main roll bar to the top of the front roll bar (or transverse member between lateral half-roll bars) to pass at least 50 mm over the top of the driver's helmet when he is seated normally in the car with his helmet on and his safety harness fastened.

9.5.2 Pedal box

The axis of the pedal box must be situated behind or directly above the axis of the front wheels.

The minimum width of the footwell must be 250 mm, maintained to a height of 250 mm, measured horizontally and perpendicularly to the longitudinal axis of the chassis directly above the pedals.

9.5.3 Floor

The floor of the cockpit extended to the front of pedal box must be closed with a metallic sheet, minimum thickness 1.5 mm.

The metallic sheet must be securely fixed to the chassis.

9.5.4 Roof

A rigid roof panel made from steel sheet, minimum 1.5 mm thick, above the driver is mandatory.

The panel may be fixed by welding to the safety cage tubes, or with a minimum of 6 M6 mm metallic bolts. The panel fixation brackets must be welded to the safety cage tubes.

If the welded panel or the fixation brackets have to be repaired, the work can only be done by the chassis safety cage manufacturer.

9.5.5 Internal parts

No part of the cockpit, or situated in the cockpit, may have sharp or pointed parts. Particular care must be taken to avoid any protrusion which could injure the driver.

9.5.6 Cockpit - lateral openings

The car must have lateral openings on both sides of the cockpit allowing the exit of the driver.

The cockpit must be designed so as to allow the driver to exit it from his normal position in the car within 7 seconds.

For the purpose of the above tests, the driver must be wearing all his equipment in accordance with Chapter 3 of Appendix L to the Code, the seat belts must be fastened, the steering wheel must be in place and in the most inconvenient position and the openings must be closed.

These openings must be closed completely to prevent the passage of a hand or arm. This closing must be effected by a metal wire grill with a maximum mesh of 25 mm x 25 mm, with a wire diameter that is a minimum of 1 mm and a maximum of 2 mm.

This grill must be attached by two hinges at the top and have an external quick release device at the bottom, also accessible from inside the car (an opening may be made for this purpose), allowing the grill to be swung upwards to a vertical position.

9.5.7 Lateral cockpit protection

The cockpit must have a lateral protection, covering the space between the upper part of the top lateral door bars to the floor level, and from the main roll bar to the most forward point of pedal box.

This protection must consist of a minimum 1.5 mm thick metallic sheet or a minimum 2.5 mm thick Kevlar or carbon-Kevlar panel (Article 279A-2.5 of Appendix J), securely fixed on the external face of the safety cage, using welded steel brackets.

9.5.8 Lateral anti-locking wheel protection

Additional to that a tube structure which must conform to the material specifications given in Article 253-8.3.3 of Appendix J, with the exception of the dimensions of the tubes, which must measure at least 30 x 2 mm, must be fixed to the base construction of the car.

This structure should not have any sharp corners.

The outermost part of the protection must be situated at the level of the centre of the wheel hubs, over a minimum length of 60% of the wheelbase.

This protection must extend outwards on both sides at least as far as the vertical planes passing through the middle of the foremost part of the rear tyres and through the middle of the rearmost part of the front tyres, but not further than the vertical planes passing through the outside of the foremost part of the rear tyres and through the outside of the rearmost part of the front tyres.

9.5.9 Fireproof bulkhead

A fireproof and liquid-proof metallic bulkhead, minimum thickness 0.8 mm, must separate the cockpit from the engine compartment.

Behind the driver's seat the bulkhead must be located from the floor up to the roof. Any object of a dangerous nature (flammable products, etc.) must be carried outside the cockpit.

10 Bodywork

10.1 Front and side bodywork

Bumpers are prohibited.

The bodywork must cover the front part of the chassis entirely.

At the front and at the sides there must be hard, opaque bodywork providing protection against stones.

At the front, this bodywork must rise at least to the level of the centre of the steering wheel, and its height must not be less than 42 cm measured from the driver's seat mounting.

The height of the side bodywork must not be less than 42 cm, measured in relation to the plane passing through the driver's seat mounting.

10.2 Rear bodywork

All parts of the transmission system should be covered by body work or mudguard. It is recommended to cover all parts of the engine when seen from above. However the panels used should be sturdy, hard and opaque. The panels used should not be more than 10mm thick.

10.3 Rear view mirrors

An external rear-view mirror must be present on each side of the car. The reflecting surface of each of these rear-view mirrors must not be less than 90 cm², and it must be possible to fit into this surface a square with sides measuring 6 cm.

10.4 Aerodynamic devices

Front aerodynamic devices are prohibited. Rear aerodynamic devices may be allowed if they are an integral part of the moulding of the bodywork and without adjustments.

10.5 Windscreen

Must be made of polycarbonate or be a metal grill.

Polycarbonate windscreen:

The thickness must not be less than 5 mm.

Cars with windscreens which are damaged to such an extent that visibility is seriously impaired or that there is a likelihood of their breaking further during the competition will be rejected.

Windscreens must not be tinted.

Metal grill:

The windscreen may be replaced, or protected, by a metal wire grill covering the entire surface of the windscreen opening. The mesh size must be between 10 mm x 10 mm and 25 mm x 25 mm, and the minimum diameter of the wire of which the mesh is formed must be 1 mm, maximum 2 mm.

In cars which have a windscreen or which have the metal grill defined above, motorcycle type goggles or a visor fitted on the helmet must be worn by the driver. Apertures of a total area not exceeding 64 cm² may be made in the windscreen.

10.6 Competition number

This must be displayed once on each side of the car and on each side of a panel on the roof or on the engine bonnet.

The car must bear no other number likely to be confused with it.

The roof number must be permanently fixed on a vertical support, 24 cm x 35 cm, with no sharp edges and must be positioned along the longitudinal axis of the car. The number must be 18 cm high and the strokes forming it must be 4 cm thick.

11 SAFETY EQUIPMENT

11.1 Driver's seat

A complete, FIA-homologated seat is mandatory (8855-1999 or 8862-2009 standards).

This seat may not be modified in any way.

The seat supports must be fixed on anchorage points for fixing seats in conformity with Construction "C" or "D" shown below, but instead of bolting the cross members to the base construction the crossmembers must be welded to the car base construction cross-wise or length-wise.

The seat supports must be fixed to the anchorage points for fixing seats via at least 4 mounting points per seat, using bolts measuring at least 8mm in diameter.

Articles 253-16.4 to 253-16.6 of Appendix J are also applicable.

The driver's seat backrest may be tilted backwards by a maximum of 15° to the vertical.

Installation proposals

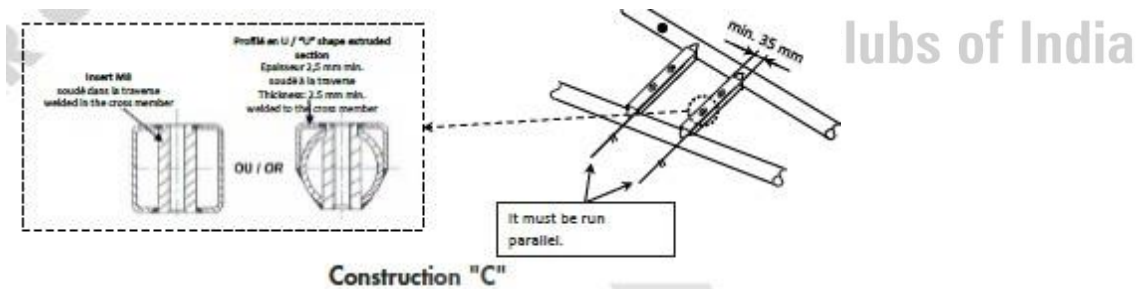

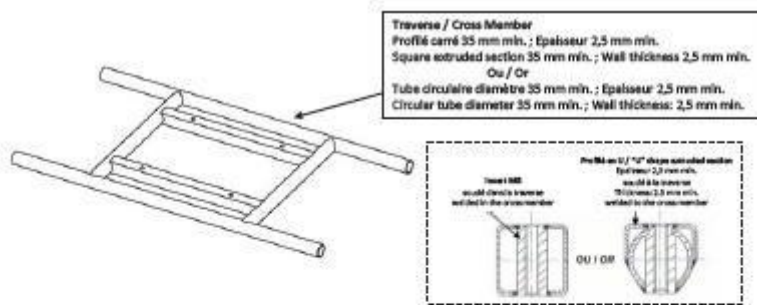

Construction "D"



11.2 Safety harness

11.2.1 Type

Compulsory, with at least six points conforming to the specifications of Article 253-6 of Appendix J.

The two shoulder straps must have separate anchorage points.

11.2.2 Installation

It is prohibited for the safety harnesses to be anchored to the seats or their supports.

A safety harness may be installed on the anchorage points of the base construction.

The recommended geometrical locations of the anchorage points are shown in Drawing 253-61 of Appendix J.

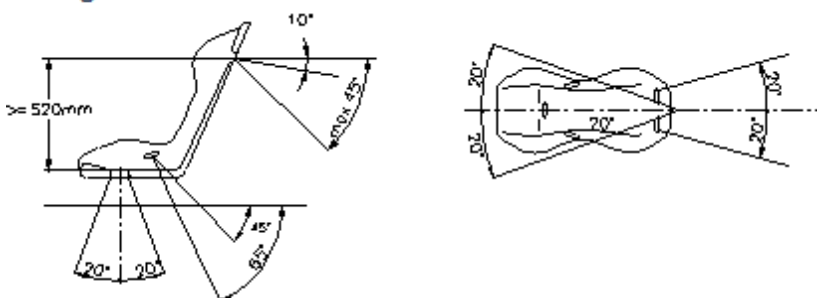

In the downwards direction, the shoulder straps must be directed towards the rear and must be installed in such a way that they do not make an angle of more than 45° to the horizontal from the upper rim of the backrest, although it is recommended that this angle does not exceed 10° .

The maximum angles in relation to the centreline of the seat are 20° divergent or convergent (the shoulder straps may be installed crosswise symmetrically about the centreline of the front seat).

The shoulder straps must be fixed to a reinforcement bar on the safety cage by means of a loop.

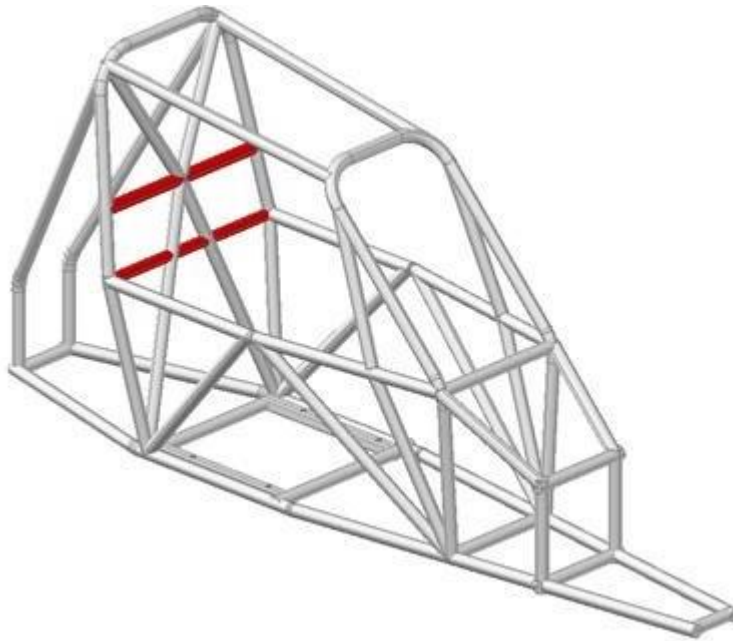

The transverse reinforcement must be a tube measuring at least 40 mm x 2 mm, made from cold drawn seamless carbon steel, with a minimum tensile strength of 350 N/mm².

The height of this reinforcement must be such that the shoulder straps, towards the rear, are directed downward with an angle of between 10° and 45° to the horizontal from the rim of the backrest, an angle of 10° being recommended.

The straps may be attached by looping or by screws, but in the latter case an insert must be welded for each mounting point (see Drawing 253-67 for the dimensions).

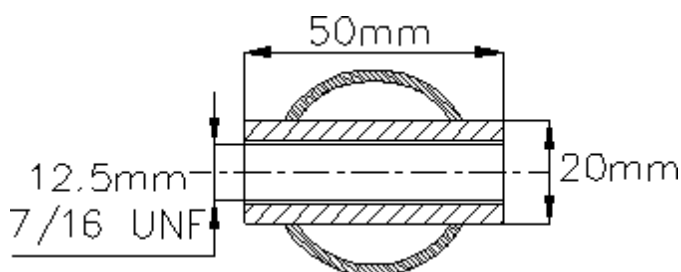

These inserts must be positioned in the reinforcement tube and the straps must be attached to them using bolts of M12 8.8 or 7/16 UNF specification.

Each anchorage point must be able to withstand a load of 15 kN.

11.3 Mudguards

It is obligatory to fix mudguards on each wheel.

They must be made of a flexible plastic material at least 4 mm thick.

They must be firmly mounted on minimum 2 mounting brackets.

The mudguards must project over the wheels and provide at all times an efficient covering of at least half of their circumference and at least the entire width of the tyre, and must be situated behind the driven wheels no more than 5 cm above the ground.

Mudguards must have no perforations or sharp angles.

Should it be necessary to reinforce the mudguards, this may be done with an aluminium alloy tubing with a maximum diameter of 15 mm.

Under no circumstances may the mudguard reinforcement be used as a pretext for the construction of crash bars. Or bumpers.

11.4 Towing device

One front and one rear towing device are compulsory.

They must:

Be clearly visible and marked in yellow, red or orange;

Allow the passage of a cylinder with a diameter of 60 mm;

Be a belt type, made from soft material;

Allow the car to be towed on a dry surface (concrete or asphalt), by applying traction on a plane parallel to the ground, with an angle of plus or minus 15 degrees to the longitudinal centreline of the car.

This check must be carried out with the wheels blocked by means of the main braking system.

The car must be fitted with tyres of a type identical to that used during the competition.

It may take place during preliminary scrutineering.

11.5 Drivers' equipment

According to Chapter 3 of Appendix L to the Code.

EXAMPLE OF DRAWING WITH ALL MANDATORY MEMBERS (BASE STRUCTURE 1)

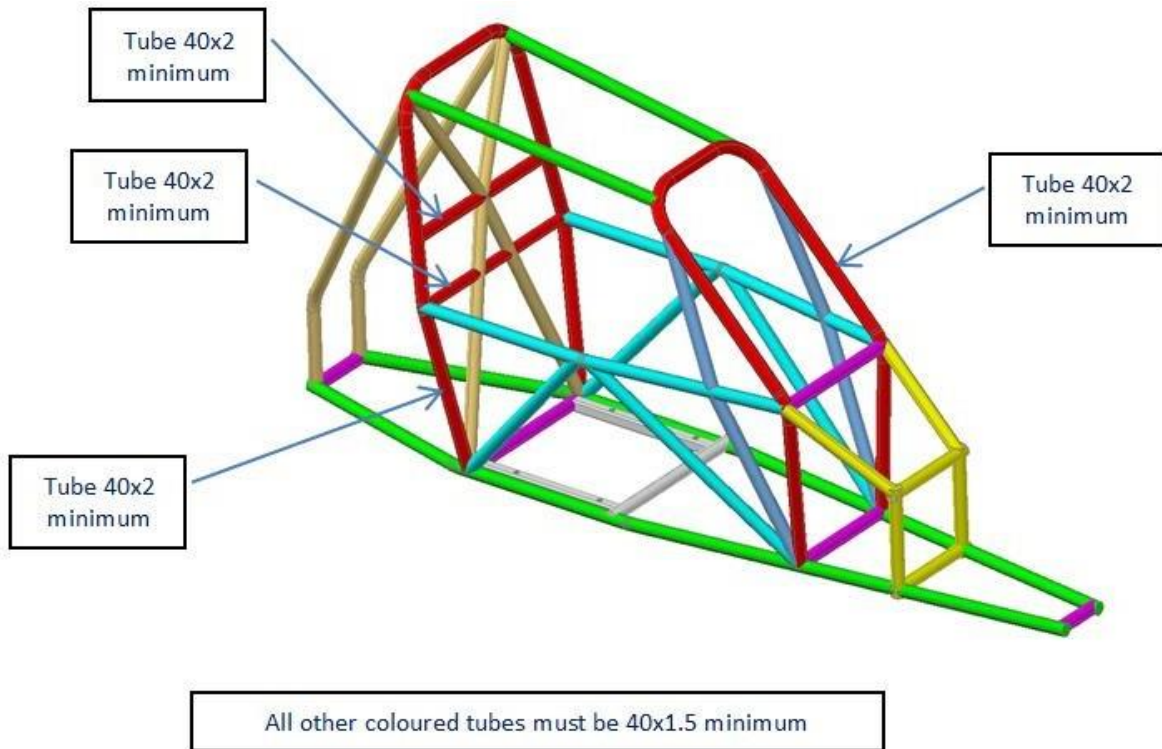

EXAMPLE OF DRAWING WITH ALL MANDATORY MEMBERS (BASE STRUCTURE 2)

